

QD80C

Universal DC/AC inverter control system for split air conditioner



1. Preface

QD80C is our latest universal control system for both DC & AC inverter split air conditioners.

Thank you for choosing this product, and it's our great pleasure to bring convenience for your daily life. Please read the user's manual carefully before using this control system, which will assist you to install and use the control system correctly.

2. Control system introduction

- 1) Parts of control system: ① universal indoor board, ② remote control, ③ universal outdoor inverter board, ④ electrolytic capacitor board.
- 2) To identify the working principle of the aircon (AC inverter or DC inverter) before installation.
- 3) No signal line is needed. Connect the outdoor inverter board with COMP terminal of the indoor board according to the wiring diagram. The control system will work normally and adjust the running frequency intelligently.
- 4) With 3 minutes' delay for protection, the compressor will restart after 3 minutes for power off or defrost.
- 5) If the aircon works absolutely nosily, check three phases to see if there are cases of phase missing or phase dislocation. Ensure the maximum compressor working current is no more than 110% of rating current of the aircon.

3. Attentions before installation

- Please hire technicians with qualification for installation and do conduct power-on test before it. There is still high voltage in the PCBA board within 3 minutes after power off. Please be careful.
- Stabilize heat sink with the original one through silicone grease to ensure better heat dissipation.
- Users just need to use the gear 1 on the outdoor inverter board to select DC inverter or AC inverter. Ensure other gears remain default setting.
- Gear 1 (default setting OFF) on outdoor inverter board is suitable for DC compressor. So before installation, please identify the compressor model (DC inverter or AC inverter). For AC inverter, please set gear 1 to be on state.
- Ensure the electrolytic capacitor positive/negative pole connect to the ⊖ and ⊕ plug of the module correctly.
- Connect the three wires (U, V, W) of the original compressor with plugs (U, V, W) of the outdoor inverter board correspondingly. Ensure the connection is stable.
- Any damage due to improper installation or burned module from human factors is not in warranty scope. If products need factory maintenance, please return the main board together with the packing box and a note to clarify specific failure phenomenon.

4. Outdoor unit instruction

4.1 Structure and installation of outdoor inverter board

1) Outdoor inverter board structure diagram

- ① Dial switch: it has 4 gears to choose. Users just need to use gear 1 to select DC inverter or AC inverter. Ensure other gears remain the default setting. The default setting (OFF) for gear 1 on outdoor inverter board is suitable for DC compressor. So before installation, please identify the compressor model (DC inverter or AC inverter). For AC inverter, please set gear 1 to be on state.

- ② Exhaust temperature sensor connection plug: when compressor exhaust temperature is higher than 110°C, it will shut down for protection.
- ③ Indicator light: when the unit is working normally, choosing DC inverter, the green LED light will be on; Choosing AC inverter, the green LED light will flicker. When failures occur, the green LED light will be off, and the red LED light will flicker. The red LED light will flicker differently according to the failure phenomenon. For details, please check the Failure Guide for reference.
- ④ COMP TERMINAL: connect with the COMP of the universal indoor board.
- ⑤ N TERMINAL: N line input.
- ⑥ ⊕ TERMINAL: connect with the positive pole of electrolytic capacitor board.
- ⑦ ⊖ TERMINAL: connect with the negative pole of electrolytic capacitor board.
- ⑧ U, V, W output terminal: connect with the wires (U, V, W) of compressor correspondingly. If it rotates reversely, please exchange two wires of them.
- ⑨ Fixed pole for radiator: stabilize the outdoor inverter board on the heat sink of the original unit.

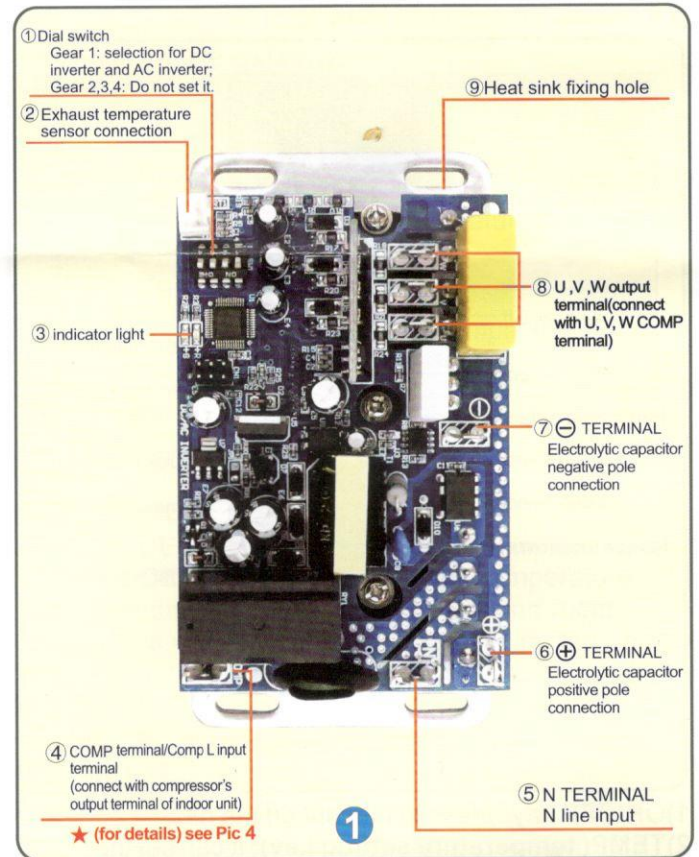

GEAR	ON	OFF
1	AC inverter	DC inverter
2	NULL	NULL
3	NULL	NULL
4	NULL	NULL

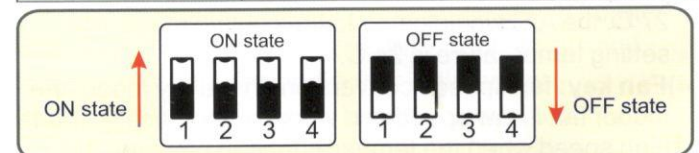

QD80C

Universal DC/AC inverter control system for split air conditioner



2) Installation for outdoor inverter board:

Test before installation:

Step 1: Test the control system to make sure it is in good condition. After power on, if the green LED light is on, which means DC inverter selected. If the green LED light flickers, which means AC inverter selected.

Step 2: Before installation, please use the ohm band of the multimeter to test the compressor and make sure the compressor coil is good and the resistance of three compressor feet is the same. If not, something may be wrong with the compressor. In that case, don't install the control system to avoid damaging it.

▲ Stabilize original heat sink with the original one through silicone grease to ensure better heat dissipation. And also use two screws to tighten up the two heat sinks.

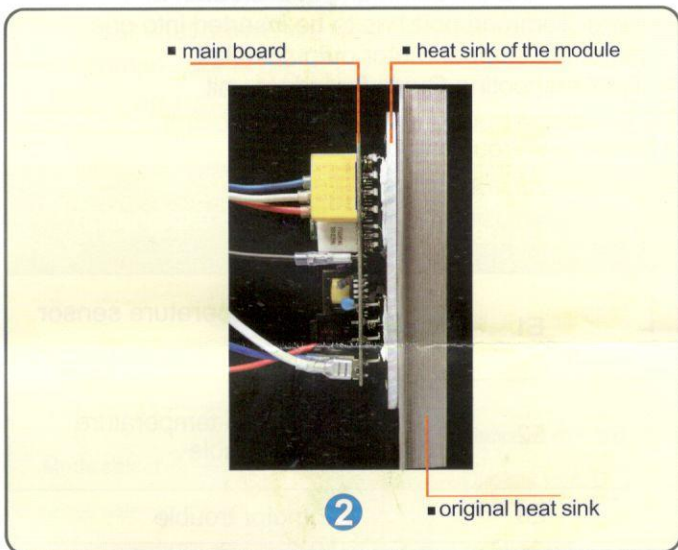

3) Install the final diagram for reference

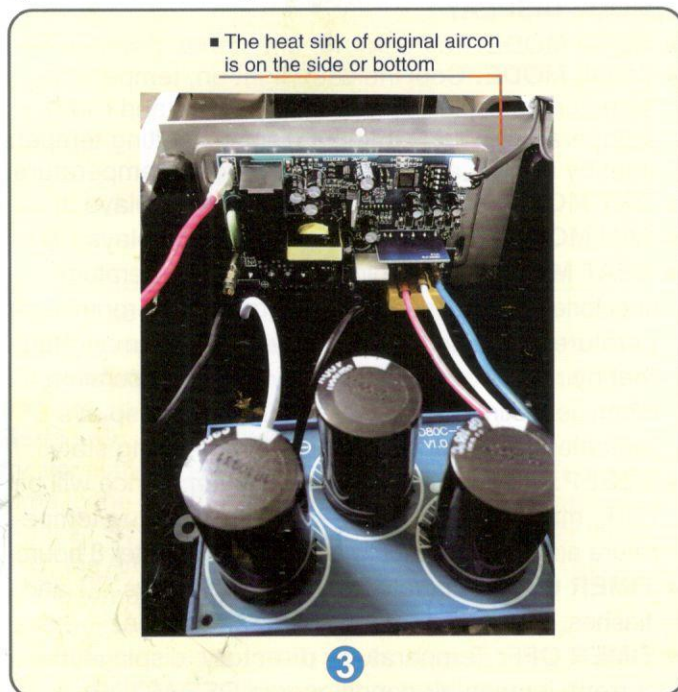

4.2 Troubleshooting Guide for Outdoor Unit

● AC inverter outdoor unit trouble code meaning:

Red LED light flashing frequency	Trouble explanation
once	DC bus over voltage and undervoltage
Twice	over current protection
3 times	IPM overcurrent protection
4 times	over exhaust temperature

● DC inverter outdoor unit trouble code meaning:

Red LED light flashing frequency	Trouble explanation
once	DC bus over voltage and undervoltage
Twice	over current protection
3 times	IPM overcurrent protection
4 times	over exhaust temperature
5 times	compressor rotor out-of-step trouble

● Note: when the outdoor unit shut-down alarm blows, identify trouble reasons and restart after power off to end the alarm.

4.3 Technical parameters

Application scope	Split air conditioner
maximum service power	12000BTU
maximum input voltage	AC240V
minimum input voltage	AC180V
maximum output current	11A
maximum output frequency	100HZ

5. Indoor unit instruction

5.1 Indoor unit wire diagram and installation instruction

1) Indoor unit for the split aircon adopts universal control system to control outdoor compressor driven module, four-way valve and the outdoor fan.

QD80C

Universal DC/AC inverter control system for split air conditioner

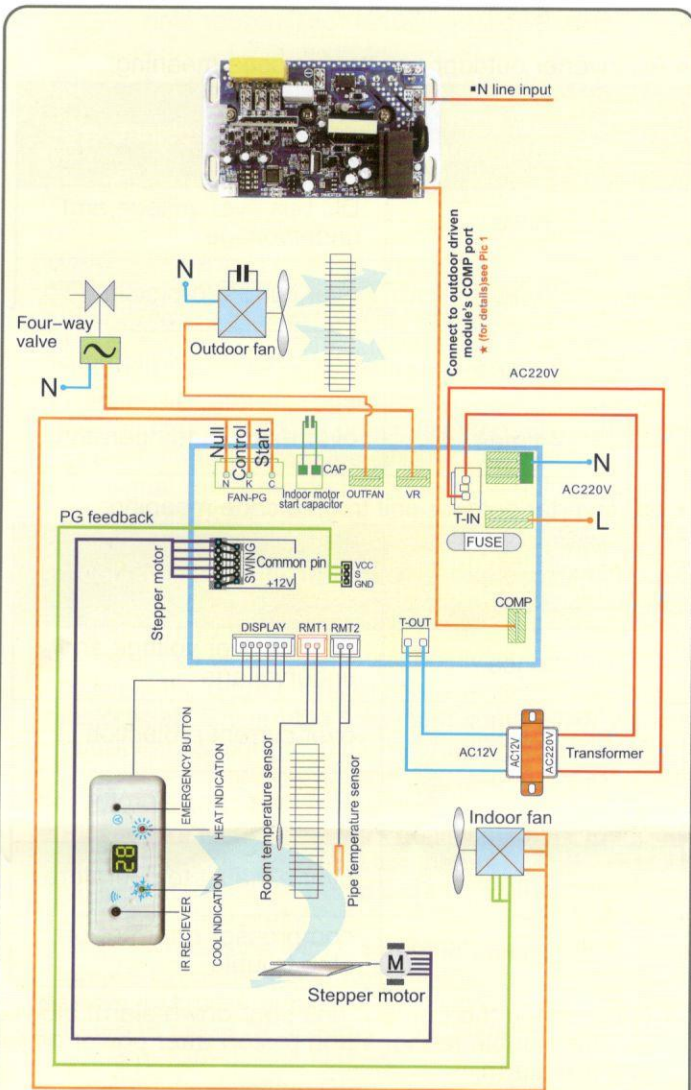

1. If PG motor doesn't work, change connection of lines according to the diagram.
2. If there is no Hall effect of the air conditioner PG motor, or Hall effect is broken, please short circuit signal pole and negative pole.

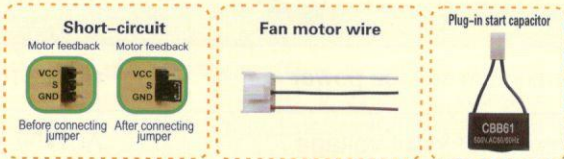

connect wires as the diagram shows if Indoor motor plugs match

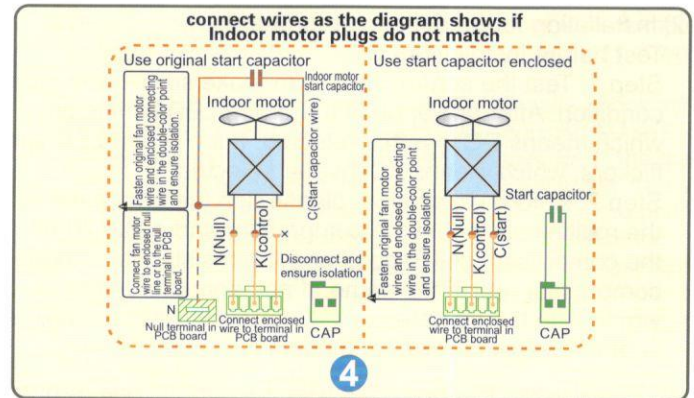
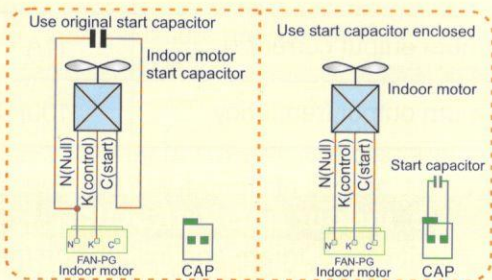

Attention:

- The stepper motor output socket (swing) is the one with six pins, and the common pin is on both ends. The swing motor common port has to be inserted into one common pin of the stepper motor output socket.
- Troubleshooting Guide for indoor unit

5.2 Troubleshooting Guide for Indoor Unit

- Indoor unit trouble code meaning

trouble display (in display panel)	Trouble explanation
E1	room temperature sensor trouble
E2	indoor pipe temperature sensor trouble
E3	PG motor trouble

5.3 indoor unit display panel instruction

1) MODE DISPLAY

- **AUTO MODE:** Temperature directory displays **RU**
- **COOL MODE:** Cool indicator light on, temperature directories display setting temperature and room temperature, when setting it displays setting temperature that by remote, and then displays room temperature.
- **DRY MODE:** Temperature directory displays **dr**
- **FAN MODE:** Temperature directory displays **FR**
- **HEAT MODE:** Heat indicator light on, temperature directories display setting temperature and room temperature, when setting it displays setting temperature that by remote, and then displays room temperature. When defrosting, Temperature directory displays **dF**, indicate that air-conditioner is in defrosting state.
- **SLEEP:** When in sleep mode, the luminance will be dark, make people have a good rest, setting temperature adjust automatically and shut down after 8 hours.
- **TIMER ON:** Temperature directory displays **ON** and flashes, it means air-conditioner in timer-on.
- **TIMER OFF:** Temperature directory displays the current, it means air-conditioner in OFF-MODE.



2)REMARKS

- **IR RECEIVER:** To receive the instruction from the remote.
- **Emergency button:** without remote, pressing this button can start air-conditioner. Press it to turn into cool mode, setting temperature will be 26°C, fan speed and direction will be automatic. Press again, it will turn into heat mode, setting temperature is 20°C, fan speed and direction will be automatic. Press again to turn off the air-conditioner. Circulating operation.

3)Compressor instruction

In heat or cool mode, when indicator light of heat and cool flashes, it means air-conditioner reaches the setting temperature, or compressor in 3 minutes protection state, compressor shut down now, when the indicator light on, it means compressor is on.

5.4 Indoor unit remote manual

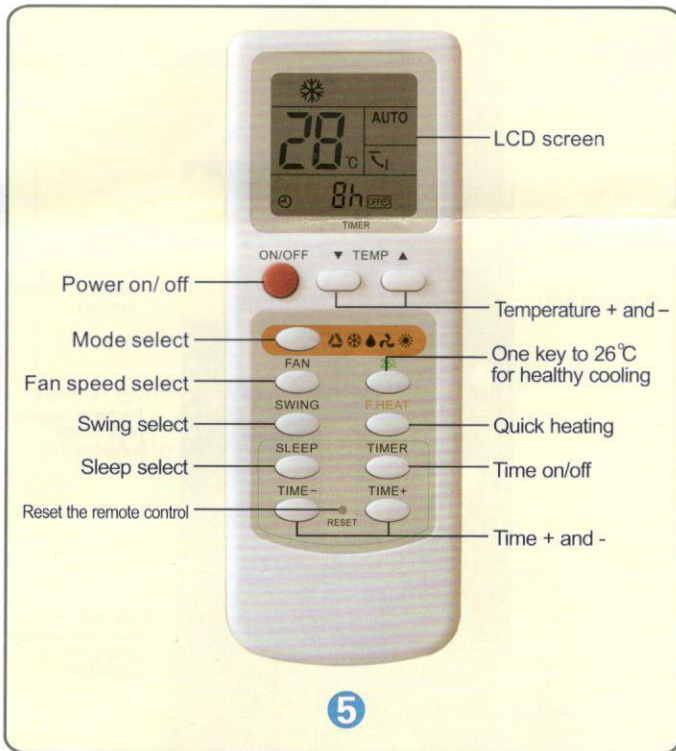

5

- 1)ON/OFF key:** press to turn on/ off the A/C.
- 2)TEMP(temperature setting key):** it can set the temperature from 16°C to 30°C. The key would not work under the auto or dry mode.
- 3)Mode key:** working modes conversion (auto, cooling, dry, ventilation, heating). In the auto mode, the A/C would come to the heating mode when the room temperature is under 21°C; when the room temperature is higher than 27°C, the A/C would come to the cooling mode. The setting temperature is 24°C.
- 4)Fan key:** fan speeds conversion. In the dry mode, the Indoor fan is low speed and works automatically: it is the high speed when the temperature gap between the

setting temperature and the room temperature is more than 4°C; 2-3°C is the middle speed; 2°C is the low speed. The wind speed would convert in every minute.

- 5)26°C key:** 26°C key would set the A/C in the cooling mode and provide you the environmental-friendly and comfortable temperature.
- 6)SWING key:** press to set the vane to swing or not.
- 7)F. HEAT key:** 20°C key would set the A/C in the heating mode and provide you the environmental-friendly and comfortable temperature.
- 8)SLEEP:** press to set the sleep mode. In the sleep mode, the fan coil would turn off automatically in 8 hours.
- 9)TIMER:** press for timer on/off or cancelling the timer.
- 10)TIME+ \ TIME-:** the time setting range from 1 to 16 hours.
- 11)RESET:** press to reset the remote control.

6. Packing components

Item	Number	Unit
universal indoor board	1	piece
indoor unit sensor	2	piece
indoor unit transformer	1	piece
indoor unit display panel	1	piece
outdoor inverter board	1	piece
Compressor exhaust temperature sensor	1	piece
outdoor electrolytic capacitor PCB board	1	piece
remote	1	piece
manual	1	piece
accessory	1	set
fan motor wire	1	piece
plug-in start capacitor	1	piece

★ Reserved the right of final explanation. Any alteration on the design and model will not be further notified.